



Torrolle aus Grauguss 250 mm, Tragkr. 320 kg

Kurzbeschreibung

Torrolle aus Grauguss

Produktbilder

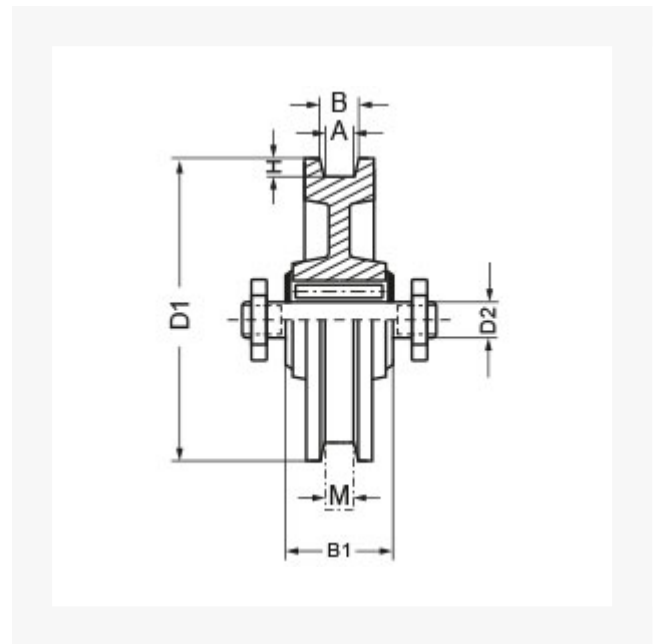

Beschreibung

Rad aus hochwertigem Grauguss, Rollenlager, Achse aus blankgezogenem Rundstahl

Zusatzinformationen

Art.-Nr.	700309
Kurzbeschreibung	Torrolle aus Grauguss
 Tragkraft kg	320 kg
 Ø Rad mm	250 mm
Radlagertyp	Rollenlager
D1	250 mm
D2	25 mm
A.B	14:17 mm
M	13 mm
B1	61 mm
H	15 mm
Material	Stahl/Grauguss