

Torrolle aus Grauguss 200 mm, Tragkr. 250 kg

Kurzbeschreibung

Torrolle aus Grauguss

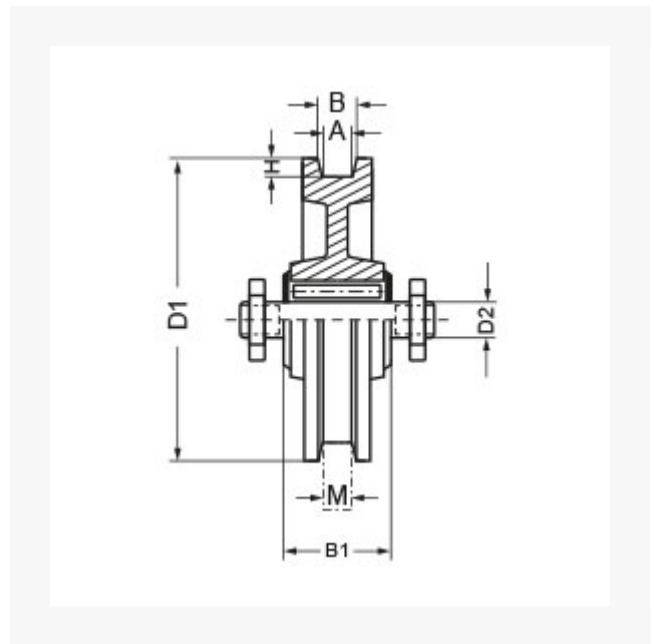

Produktbilder



Beschreibung

Rad aus hochwertigem Grauguss, Rollenlager, Achse aus blankgezogenem Rundstahl

Zusatzinformationen

Art.-Nr.	700308
Kurzbeschreibung	Torrolle aus Grauguss
 Tragkraft kg	250 kg
 Ø Rad mm	200 mm
Radlagertyp	Rollenlager
D1	200 mm
D2	16 mm
A.B	14:17 mm
M	13 mm
B1	49 mm
H	10 mm
Material	Stahl/Grauguss