

Torrolle aus Grauguss 120 mm, Tragkr. 100 kg

Kurzbeschreibung

Torrolle aus Grauguss

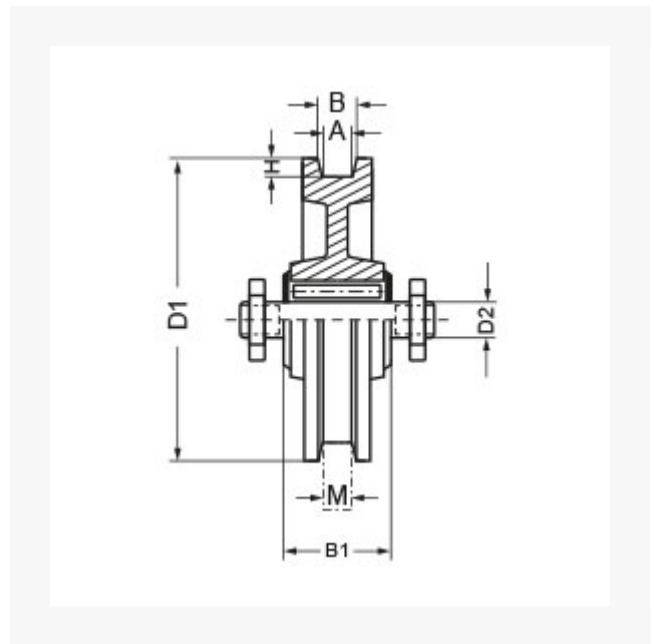

Produktbilder



Beschreibung

Rad aus hochwertigem Grauguss, Rollenlager, Achse aus blankgezogenem Rundstahl

Zusatzinformationen

Art.-Nr.	700305
Kurzbeschreibung	Torrolle aus Grauguss
 Tragkraft kg	100 kg
 Ø Rad mm	120 mm
Radlagertyp	Rollenlager
D1	120 mm
D2	12 mm
A.B	11:13 mm
M	10 mm
B1	39 mm
H	9 mm
Material	Stahl/Grauguss