



Torrolle aus Grauguss 90 mm, Tragkr. 50 kg

Kurzbeschreibung

Torrolle aus Grauguss

Produktbilder

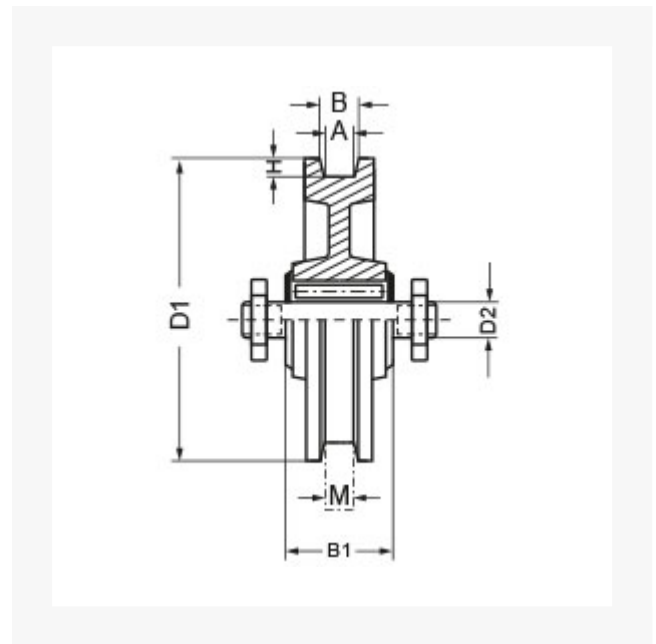

Beschreibung

Rad aus hochwertigem Grauguss, Rollenlager, Achse aus blankgezogenem Rundstahl

Zusatzinformationen

Art.-Nr.	700303
Kurzbeschreibung	Torrolle aus Grauguss
 Tragkraft kg	50 kg
 Ø Rad mm	90 mm
Radlagertyp	Rollenlager
D1	90 mm
D2	10 mm
A.B	9:11 mm
M	8 mm
B1	32 mm
H	8 mm
Material	Stahl/Grauguss