



## Torrolle aus Grauguss 75 mm, Tragkr. 35 kg

### Kurzbeschreibung

Torrolle aus Grauguss

### Produktbilder

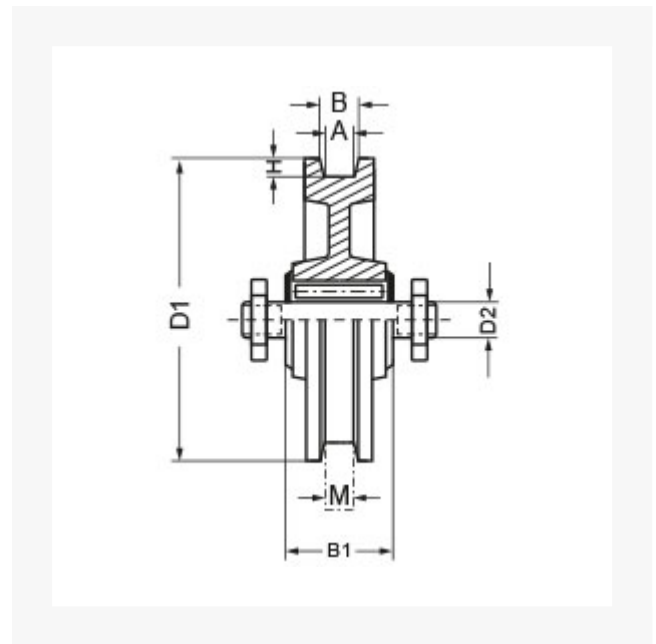

### Beschreibung

Rad aus hochwertigem Grauguss, Rollenlager, Achse aus blankgezogenem Rundstahl

## Zusatzinformationen

Art.-Nr.	700302
Kurzbeschreibung	Torrolle aus Grauguss
 Tragkraft kg	35 kg
 Ø Rad mm	75 mm
Radlagertyp	Rollenlager
D1	75 mm
D2	10 mm
A.B	9:11 mm
M	8 mm
B1	28 mm
H	8 mm
Material	Stahl/Grauguss